



































SALES ORDER - SUN
[effective 09/22/11]
paul frank

Baumvision Incorporated
3100 Pullman St. Unit C, Costa Mesa, CA 92626 USA
p:949.645.8783 f:949.548.0454 e:info@baumvision.com

bill to:	ship to:	phone:	fax:	customer p.o.:
				start ship date:
		e.mail:		terms:
				sales rep.:

60□13-150  088 LOVERS IN THE BACKSEAT QTY. burgundy/seafoam burgundy burnt umber cranberry off white stripe	60□13-133  118 LEGION OF INDECENCY QTY. black burgundy burnt umber matte brown/orange ★see limited edition section	57□15-140  144 FAR AWAY AND LOST IN JOY QTY. burnt umber caramel/seafoam cranberry crimson stripe ★see limited edition section	55□17-140  152 INSTANT INTELLECTUAL (S) QTY. matte black new millennium tortoise	59□15-140  159 NO THRILLS FOR THE CAUTIOUS QTY. black brown/gold pearl burgundy/seafoam new millennium tortoise	★ LIMITED EDITION FRAMES QTY. 089 FIST FULL OF DOLLARS - GREY/PINK PEARL 099 FIST FULL OF DOLLARS - SEA/GREEN PEARL 104 THE CRAFTY ENGINEER - BROWN/GOLD PEARL 104 THE CRAFTY ENGINEER - GREY/PINK PEARL 118 LEGION OF INDECENCY - BROWN/GOLD PEARL 118 LEGION OF INDECENCY - SEA/GREEN PEARL 131 OLYMPIC AIRWAYS - BROWN/GOLD PEARL 131 OLYMPIC AIRWAYS - SEA/GREEN PEARL 135 THE SPORTING LIFE - BROWN/GOLD PEARL 135 THE SPORTING LIFE - SEA/GREEN PEARL 135 THE SPORTING LIFE - SEA/GREEN PEARL 138 BYE BYE BLUES - BLUE ICE 138 BYE BYE BLUES - GREY/PINK PEARL 144 FAR AWAY AND LOST IN JOY - GREY/PINK PEARL 144 FAR AWAY AND LOST IN JOY - SEA/GREEN PEARL 148 A SACRIFICE TO SOPHISTICATION - BROWN/GOLD PEARL 148 A SACRIFICE TO SOPHISTICATION - SEA/GREEN PEARL 154 LOST IN THE LIBRARY - BROWN/GOLD PEARL 155 SLEEPLESS IN SILVERLAKE - BROWN/GOLD PEARL 155 SLEEPLESS IN SILVERLAKE - SEA/GREEN PEARL 156 BRAND NEW DAY - BROWN/GOLD PEARL 157 UNTIL THE BIRDS RETURN - SEA/GREEN PEARL 158 STARSTRUCK - BROWN/GOLD PEARL 158 STARSTRUCK - SEA/GREEN PEARL
65□12-130  073 JETS TO BRAZIL QTY. aqua/seafoam azure stripe black burnt umber burgundy/seafoam burgundy crimson stripe white/brown	59□14-130  122 GOLD IN THE AIR OF SUMMER QTY. amber/yellow burgundy/seafoam burnt umber cranberry crimson stripe white/brown	58□15-140  145 CINEMA OLYMPIA QTY. black burnt umber crimson stripe white/brown	56□15-140  153 TOMORROW NOON (S) QTY. black new millennium tortoise	58□15-140  PF160: SUBTLE AND SURE QTY. brown/gold pearl black new millennium tortoise grey/pink pearl	131 OLYMPIC AIRWAYS - SEA/GREEN PEARL 135 THE SPORTING LIFE - BROWN/GOLD PEARL 135 THE SPORTING LIFE - GREY/PINK PEARL 135 THE SPORTING LIFE - SEA/GREEN PEARL 138 BYE BYE BLUES - BLUE ICE 138 BYE BYE BLUES - GREY/PINK PEARL 144 FAR AWAY AND LOST IN JOY - GREY/PINK PEARL 144 FAR AWAY AND LOST IN JOY - SEA/GREEN PEARL 148 A SACRIFICE TO SOPHISTICATION - BROWN/GOLD PEARL 148 A SACRIFICE TO SOPHISTICATION - SEA/GREEN PEARL 154 LOST IN THE LIBRARY - BROWN/GOLD PEARL 155 SLEEPLESS IN SILVERLAKE - BROWN/GOLD PEARL 155 SLEEPLESS IN SILVERLAKE - SEA/GREEN PEARL 156 BRAND NEW DAY - BROWN/GOLD PEARL 157 UNTIL THE BIRDS RETURN - SEA/GREEN PEARL 158 STARSTRUCK - BROWN/GOLD PEARL 158 STARSTRUCK - SEA/GREEN PEARL
61□12.7-135  089 FIST FULL OF DOLLARS QTY. azure stripe black burgundy/seafoam burgundy burnt umber chocolate stripe cranberry white/brown ★see limited edition section	59□16-135  126 WHITE LIPS KISSED QTY. burgundy/seafoam burnt umber cranberry white/brown	56□15-138  147 LOVERS IN THE SPRINGTIME QTY. black cranberry new millennium tortoise white/brown	53□17-140  154 LOST IN THE LIBRARY (S) QTY. black caramel/seafoam matte black new millennium tortoise ★see limited edition section	57□19-140  PF161: I'M YOUR SUNSHINE QTY. matte black new millennium tortoise matte brown/orange burgundy/seafoam slate	148 A SACRIFICE TO SOPHISTICATION - BROWN/GOLD PEARL 148 A SACRIFICE TO SOPHISTICATION - SEA/GREEN PEARL 154 LOST IN THE LIBRARY - BROWN/GOLD PEARL 155 SLEEPLESS IN SILVERLAKE - BROWN/GOLD PEARL 155 SLEEPLESS IN SILVERLAKE - SEA/GREEN PEARL 156 BRAND NEW DAY - BROWN/GOLD PEARL 157 UNTIL THE BIRDS RETURN - SEA/GREEN PEARL 158 STARSTRUCK - BROWN/GOLD PEARL 158 STARSTRUCK - SEA/GREEN PEARL
56□18-135  104 THE CRAFTY ENGINEER QTY. aqua/seafoam black burnt umber matte black new millennium tortoise white/brown ★see limited edition section	60□09-135  131 OLYMPIC AIRWAYS QTY. black burnt umber matte black new millennium tortoise white/brown ★see limited edition section	53□19-138  148 A SACRIFICE TO SOPHISTICATION QTY. black cranberry matte black new millennium tortoise white/brown ★see limited edition section	55□19-140  155 SLEEPLESS IN SILVERLAKE QTY. black new millennium tortoise ★see limited edition section	56□17-140  PF162: THE WALKABOUT QTY. matte black new millennium tortoise matte brown/orange burgundy/seafoam slate	NOTES
62□12-133  111 FLUORESCENT ADOLESCENT QTY. black burgundy/seafoam burgundy burnt umber cranberry white/brown	60□12-138  135 THE SPORTING LIFE QTY. azure stripe black burnt umber cranberry crimson stripe sienna stripe white/brown ★see limited edition section	54□18-140  149 I'D RATHER DANCE WITH YOU QTY. black cranberry matte black matte brown/orange new millennium tortoise	61□14-135  156 BRAND NEW DAY QTY. burgundy burgundy/seafoam new millennium tortoise ★see limited edition section	60□14-140  PF163: SUGARETTE QTY. black grey/pink pearl crimson stripe burnt umber slate cobalt	
61□13-135  113 BENEATH THE BLEACHERS QTY. burgundy/seafoam burnt umber crimson stripe white/brown	60□13-138  138 BYE BYE BLUES QTY. burnt umber cranberry white/brown ★see limited edition section	53□15-140  150 THE STARS WHERE WE CAME FROM QTY. black burnt umber cranberry matte brown/orange new millennium tortoise white/brown	57□15-138  157 UNTIL THE BIRDS RETURN QTY. burgundy/seafoam burnt umber new millennium tortoise ★see limited edition section	53□18-140  PF164: MEMORIES OF THE FUTURE QTY. matte black burgundy/seafoam new millennium tortoise brown/gold pearl matte brown/orange slate	
60□15-130  116 SLINGSHOT QTY. black burgundy burnt umber	59□12-138  142 MY DAILY VACATION QTY. burnt umber caramel/seafoam cranberry white/brown	58□15-140  151 MY EXCUSE TO TRAVEL QTY. black burnt umber cranberry matte brown/orange new millennium tortoise white/brown	56□14-140  158 STARSTRUCK QTY. burgundy/seafoam new millennium tortoise ★see limited edition section		







































THIS ORDER IS AN IRREVOCABLE CONTRACT.
The undersigned agrees to pay for all purchases according to the terms of the Creditor. No terms or conditions of purchase orders different from the terms of the Creditor, will become part of any sales agreement, purchase order, or other document unless specifically approved in writing by Creditor. No items will be accepted without prior approval and return authorization number. Any defective merchandise must be returned within (10) ten days of receipt of goods. The undersigned agrees that all amounts payable on or before the due date as shown on each invoice, will be paid in full. And, if not paid on or before said date, will be delinquent. It is understood on any Creditor may impose and charge a finance charge at the rate of 1.5% per month from due date until paid on any amount which becomes past due and delinquent. All accounts shall be responsible for all collection cost and attorney's fees in connection with the delinquent amount. Prices subject to change.

buyer signature _____ print name _____ date _____ total pieces _____ total amount: _____

SALES ORDER - RX
[effective 09/22/11]
paul frank

Baumvision Incorporated
3100 Pullman St. Unit C, Costa Mesa, CA 92626 USA
p:949.645.8783 f:949.548.0454 e:info@baumvision.com

bill to:	ship to:	phone:	fax:	customer p.o.:
				start ship date:
		e-mail:		terms:
				sales rep.:

<p>52.5 □ 17-140</p> <p>RX5 BLUES EXPLOSION QTY.</p>  <p>black burgundy caramel/seafoam dark brown light brown stripe new millennium tortoise</p>	<p>55 □ 18-140</p> <p>RX45 STYLE COUNCIL LUNCHBREAK QTY.</p>  <p>black burgundy/seafoam new millennium tortoise</p>	<p>49 □ 18-140</p> <p>RX60 A FRIEND IN TWEED IS A FRIEND INDEED QTY.</p>  <p>aqua/seafoam black burgundy/seafoam burnt umber crimson stripe new millennium tortoise matte brown/orange sienna stripe</p>	<p>57 □ 12-140</p> <p>RX74 ELEVATOR EYES QTY.</p>  <p>black crimson stripe matte brown/orange sienna stripe</p>	<p>46 □ 18-135</p> <p>RX82 A SENTIMENTAL MOOD QTY.</p>  <p>black burnt umber cranberry crimson stripe matte brown/orange</p>	<p>54 □ 17-140</p> <p>RX97: WRAPPED IN DISCOURSE QTY.</p>  <p>burnt umber burgundy grey/pink pearl crimson stripe cobalt</p>
<p>54 □ 16-135</p> <p>RX7 PINKERTON QTY.</p>  <p>black burgundy caramel/seafoam cranberry dark brown light brown stripe sienna stripe</p>	<p>55 □ 18-140</p> <p>RX46 STAR CLAIMER QTY.</p>  <p>black brown/gold pearl burnt umber new millennium tortoise</p>	<p>56 □ 15-140</p> <p>RX66 POST AEROSOL YEARS QTY.</p>  <p>aqua/seafoam burgundy/seafoam burnt umber white/brown</p>	<p>48 □ 16-135</p> <p>RX76 UNTIL NEXT SUMMER QTY.</p>  <p>azure stripe black burgundy/seafoam matte brown/orange</p>	<p>56 □ 15-140</p> <p>RX83 TOMORROW NOON QTY.</p>  <p>black burnt umber cranberry new millennium tortoise</p>	<p>53 □ 18-140</p> <p>RX98: MEMORIES OF THE FUTURE QTY.</p>  <p>matte black burgundy/seafoam new millennium tortoise brown/gold pearl matte brown/orange slate</p>
<p>53 □ 13-140</p> <p>RX25 BEAT POET HOLIDAY QTY.</p>  <p>black brown/gold pearl brown/orange caramel/seafoam light brown stripe new millennium tortoise</p>	<p>54 □ 17-140</p> <p>RX47 TRIED AND TRUE QTY.</p>  <p>black burnt umber cranberry crimson stripe grey/pink pearl new millennium tortoise sienna stripe</p>	<p>55 □ 17-140</p> <p>RX67 INSTANT INTELLECTUAL QTY.</p>  <p>aqua/seafoam black burnt umber burgundy/seafoam burnt umber matte black new millennium tortoise white/brown</p>	<p>54 □ 16-140</p> <p>RX77 HIGHWAY TO HELL-0 QTY.</p>  <p>black burnt umber crimson stripe new millennium tortoise matte brown/orange</p>	<p>52 □ 18-140</p> <p>RX84 WITH YOU IN ROCKLAND QTY.</p>  <p>black brown/gold pearl burnt umber new millennium tortoise sea/green pearl</p>	<p>55 □ 15-140</p> <p>RX99: BOMBAY BOOK CLUB QTY.</p>  <p>matte black burgundy/seafoam new millennium tortoise brown/gold pearl matte brown/orange</p>
<p>55 □ 15-140</p> <p>RX27 A IS FOR ACTION QTY.</p>  <p>black burnt umber caramel/seafoam cranberry crimson stripe dark brown grey/pink pearl light brown stripe matte brown/orange new millennium tortoise sienna stripe</p>	<p>54 □ 16-135</p> <p>RX55 HIDDEN HANDSHAKE QTY.</p>  <p>black caramel/seafoam light brown stripe matte brown/orange</p>	<p>54 □ 17-140</p> <p>RX68 BLUE SKY REVOLUTION QTY.</p>  <p>black burgundy/seafoam burnt umber matte black new millennium tortoise white/brown</p>	<p>51 □ 17-135</p> <p>RX78 HIGHER THAN THE STARS QTY.</p>  <p>azure stripe black crimson stripe new millennium tortoise sienna stripe</p>	<p>51 □ 18-140</p> <p>RX85 HOLD MY HAND AS WE ASCEND QTY.</p>  <p>black brown/gold pearl burnt umber new millennium tortoise sea/green pearl</p>	<p>57 □ 17-140</p> <p>RX100: LET'S GET LOST QTY.</p>  <p>matte black burgundy/seafoam new millennium tortoise brown/gold pearl matte brown/orange</p>
<p>57 □ 15-140</p> <p>RX32 SELF PRESERVATION SOCIETY QTY.</p>  <p>azure stripe black brown/gold pearl burgundy/seafoam burnt umber caramel/seafoam crimson stripe new millennium tortoise sienna stripe</p>	<p>58 □ 15-135</p> <p>RX56 MUSTACHE MUSEUM QTY.</p>  <p>black light brown stripe matte brown/orange</p>	<p>56 □ 15-138</p> <p>RX70 MY HEART RATES RAPID QTY.</p>  <p>black matte brown/orange</p>	<p>50 □ 15-138</p> <p>RX79 HOPSCOTCH HOLIDAY QTY.</p>  <p>azure stripe black caramel/seafoam crimson stripe new millennium tortoise sienna stripe</p>	<p>53 □ 17-135</p> <p>RX86 CLEAR SPIRITS QTY.</p>  <p>black brown/gold pearl burgundy/seafoam grey/pink pearl new millennium tortoise</p>	<p>NOTES</p>
<p>53 □ 16-135</p> <p>RX35 ALL NIGHT DISCO PARTY QTY.</p>  <p>black burgundy burnt umber chocolate stripe cranberry crimson stripe matte brown/orange sienna stripe</p>	<p>53 □ 17-140</p> <p>RX58 LOST IN THE LIBRARY QTY.</p>  <p>aqua/seafoam azure stripe black brown/gold pearl burnt umber crimson stripe matte black matte brown/orange new millennium tortoise sienna stripe tortoise</p>	<p>51 □ 17-140</p> <p>RX71 TOUR DE FRIENDS QTY.</p>  <p>azure stripe black brown/gold pearl burnt umber cranberry crimson stripe matte brown/orange new millennium tortoise sea/green pearl sienna stripe</p>	<p>47 □ 19-140</p> <p>RX80 BLANK GENERATION QTY.</p>  <p>black burnt umber crimson stripe matte brown/orange white/brown</p>	<p>53 □ 17-140</p> <p>RX87 KID ROYALE QTY.</p>  <p>black brown/gold pearl matte black new millennium tortoise white/brown</p>	
<p>50 □ 16-135</p> <p>RX44 MINIATURE PHILOSOPHER QTY.</p>  <p>black burnt umber cranberry new millennium tortoise sienna stripe tortoise</p>	<p>54 □ 17-135</p> <p>RX59 THE PATH OF LEAST RESISTANCE QTY.</p>  <p>black burnt umber crimson stripe grey/pink pearl light brown stripe new millennium tortoise sea/green pearl sienna stripe</p>	<p>51 □ 18-140</p> <p>RX72 FINDING FOCUS WITHIN QTY.</p>  <p>black burnt umber cranberry crimson stripe grey/pink pearl matte brown/orange new millennium tortoise sea/green pearl sienna stripe</p>	<p>51 □ 19-140</p> <p>RX81 BLANK GENERATION QTY.</p>  <p>black burnt umber crimson stripe matte brown/orange white/brown</p>	<p>52 □ 16-140</p> <p>RX86 : MATTER OF FACT QTY.</p>  <p>black burnt umber burgundy grey/pink pearl crimson stripe slate</p>	

THIS ORDER IS AN IRREVOCABLE CONTRACT.

The undersigned agrees to pay for all purchases according to the terms of the Creditor. No terms or conditions of purchase orders different from the terms of the Creditor, will become part of any sales agreement, purchase order, or other document unless specifically approved in writing by Creditor. No items will be accepted without prior approval and return authorization number. Any defective merchandise must be returned within (10) ten days of receipt of goods. The undersigned agrees that all amounts payable on or before the due date as shown on each invoice, will be paid in full. And, if not paid on or before said date, will be delinquent. It is understood on any Creditor may impose and charge a finance charge at the rate of 1.5% per month from due date until paid on any amount which becomes past due and delinquent. All accounts shall be responsible for all collection cost and attorney's fees in connection with the delinquent amount. Prices subject to change.

buyer signature _____ print name _____ date _____ total pieces _____ total amount: _____

paul frank
PF MAGNET COLLECTION 2011 - SALES ORDER FORM
Global Headquarters **European Headquarters**
 Baumvision Incorporated Baumvision Europe, Ltd.
 3100 Pullman St. Unit C Wiedner Gürtel 12 Top AA
 Costa Mesa, CA 92626 1040 Vienna, Austria
 tel: 1.949.645.8783 tel: +43.1.924.6303
 fax: 1.949.548.0454 fax: +43.1.924.6306
 email: info@baumvision.com email: office@baumvisioneurope.com

bill to:

ship to:

phone:	fax:
e-mail:	

customer p.o.:	
start ship date:	
terms:	sales rep.:

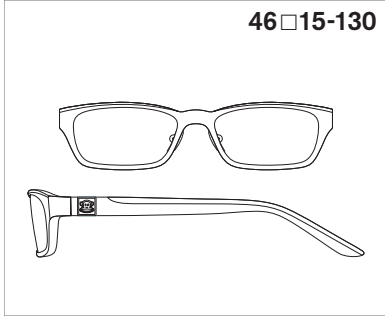

RX88 THE SOURCE AND THE SOUND	QTY.
black	
burgundy	
caramel/seafoam	
grey/pink pearl	

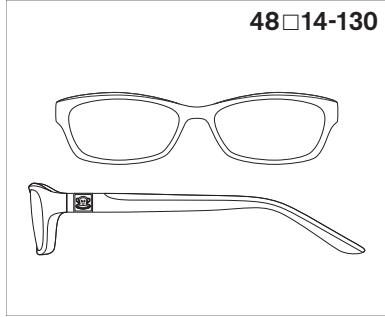

RX92 MUST BE THE MOONLIGHT	QTY.
burgundy	
caramel/seafoam	
crimson stripe	
grey/pink pearl	

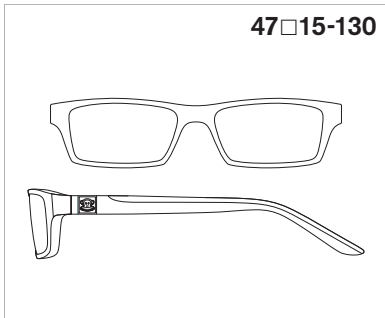

RX89 YOUNG PILOT ASTRAY	QTY.
black	
burgundy	
burnt umber	
caramel/seafoam	

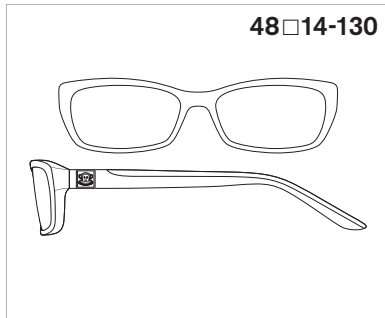

RX93 INTERSTELLAR	QTY.
burgundy/seafoam	
burgundy	
crimson stripe	
grey/pink pearl	

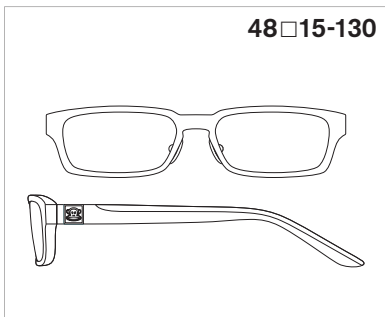

RX90 FOREVER OKAY	QTY.
black	
burnt umber	
new millennium tortoise	

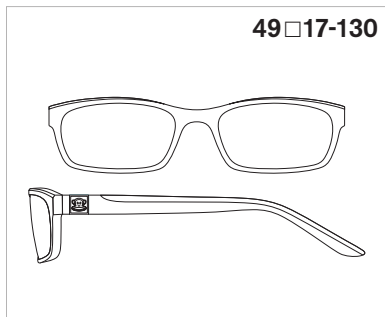

RX94 CLAIREVOYAGE	QTY.
black	
burgundy/seafoam	
burgundy	
new millennium tortoise	

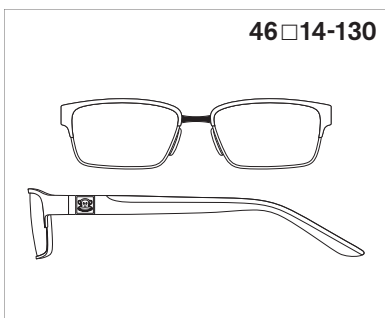

RX91 CONVERTIBLE BALLOON	QTY.
burnt umber	
grey/pink pearl	
matte black	



RX95 MISTER PLEASANT	QTY.
black	
crimson stripe	
grey/pink pearl	
new millennium tortoise	

THIS ORDER IS AN IRREVOCABLE CONTRACT.
 The undersigned agrees to pay for all purchases according to the terms of the Creditor. No terms or conditions of purchase orders different from the terms of the Creditor, will become part of any sales agreement, purchase order, or other document unless specifically approved in writing by Creditor. No items will be accepted without prior approval and return authorization number. Any defective merchandise must be returned within (10) ten days of receipt of goods. The undersigned agrees that all amounts payable on or before the due date as shown on each invoice, will be paid in full. And, if not paid on or before said date, will be delinquent. It is understood on any Creditor may impose and charge a finance charge at the rate of 1.5% per month from due date until paid on any amount which becomes past due and delinquent. All accounts shall be responsible for all collection cost and attorney's fees in connection with the delinquent amount. Prices subject to change.

buyer signature _____ print name _____ date _____ total pieces _____ total amount: _____